

*Terrace 28 3913*  
*Art.Nr. 285400*

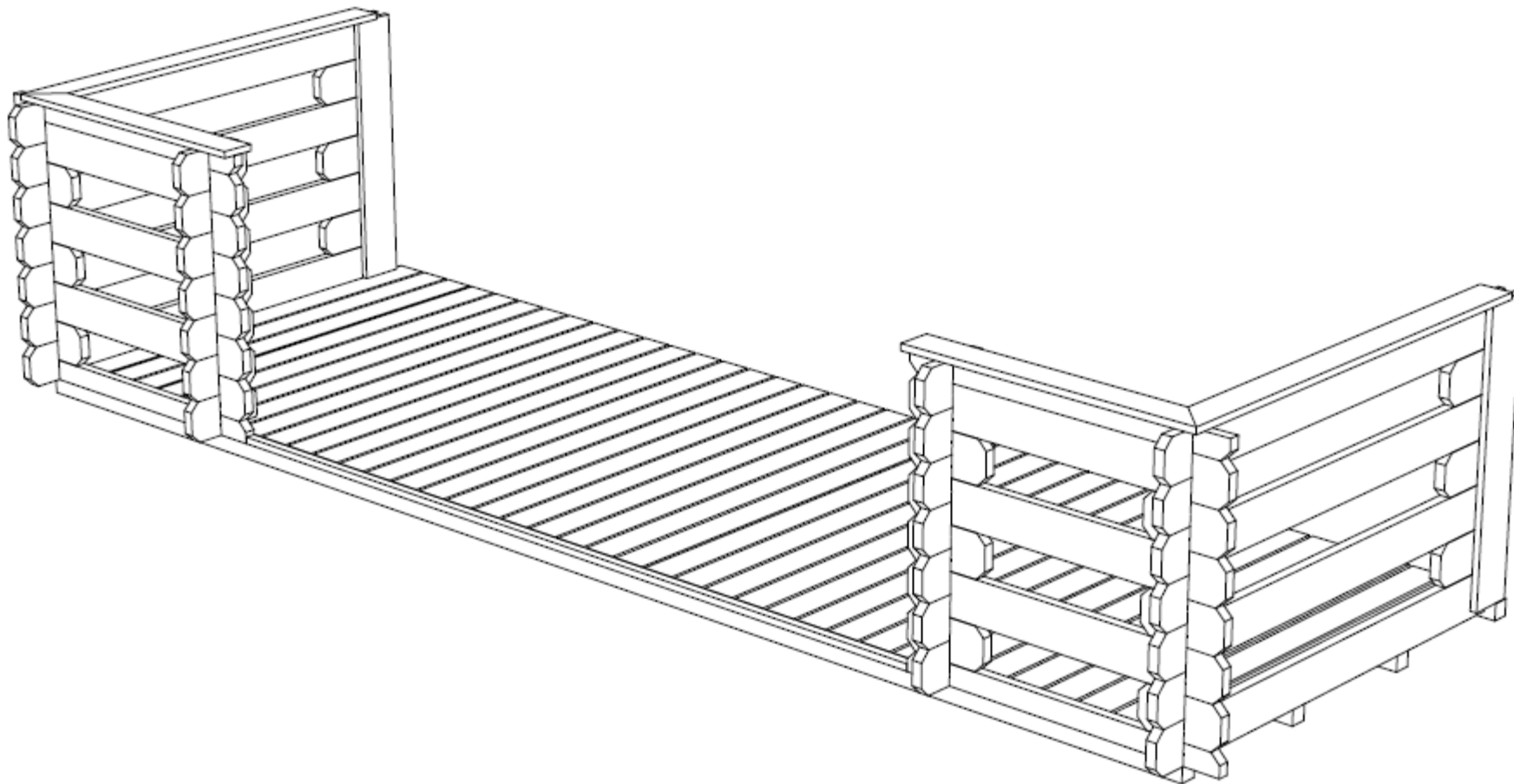

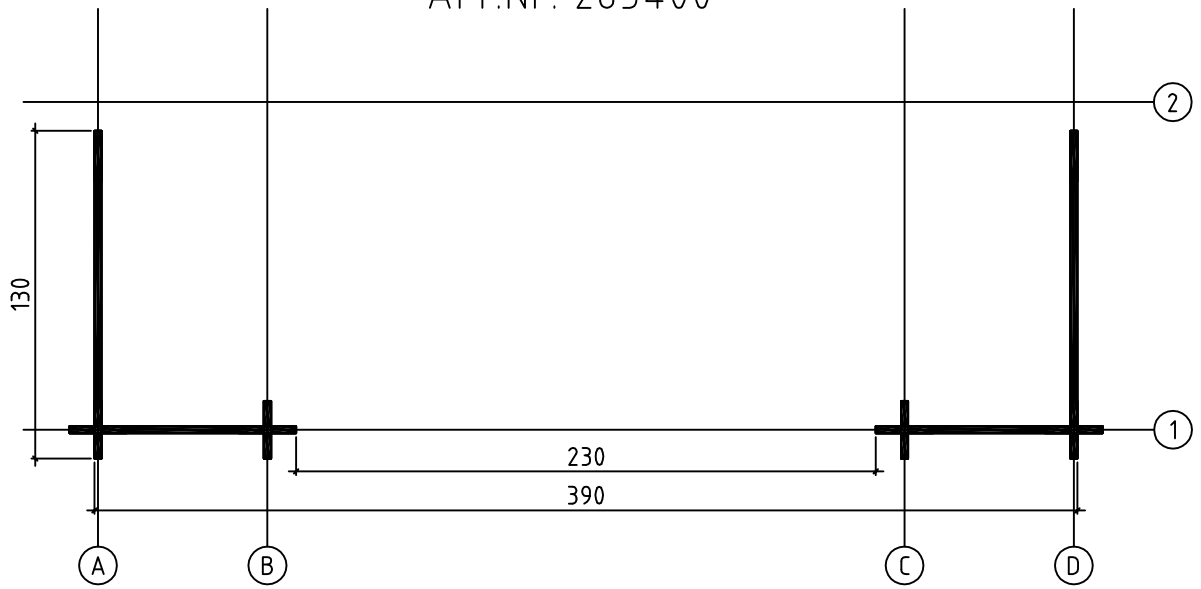

GROUNDPLAN - GRUNDPLAN - PLAN DE MASSE

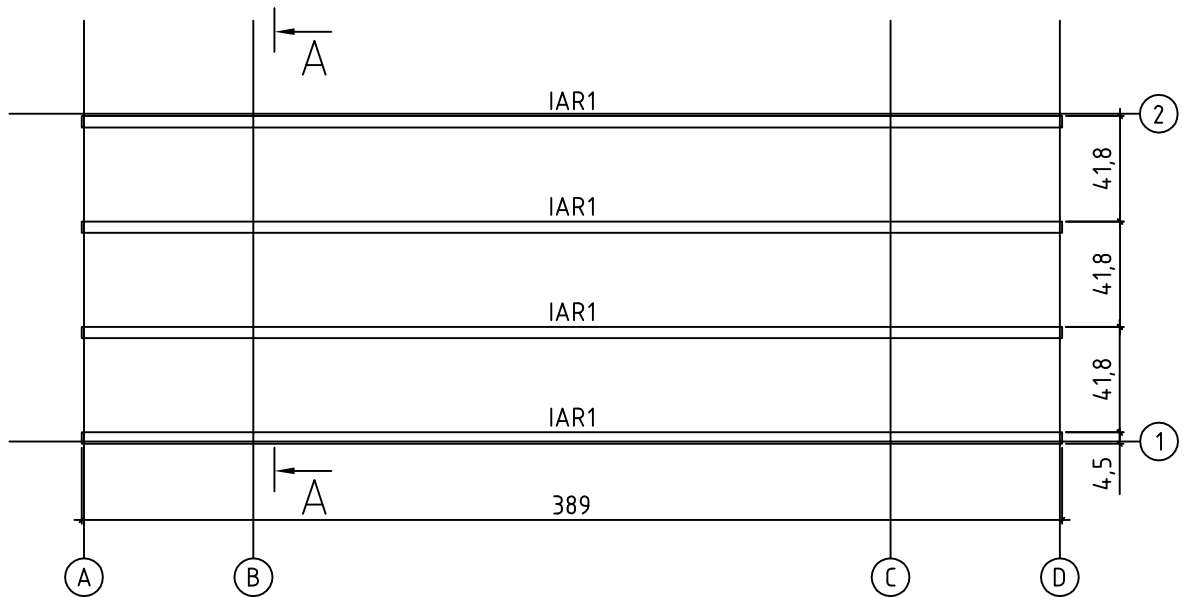

FOUNDATION - FUNDAMENT - FONDATION

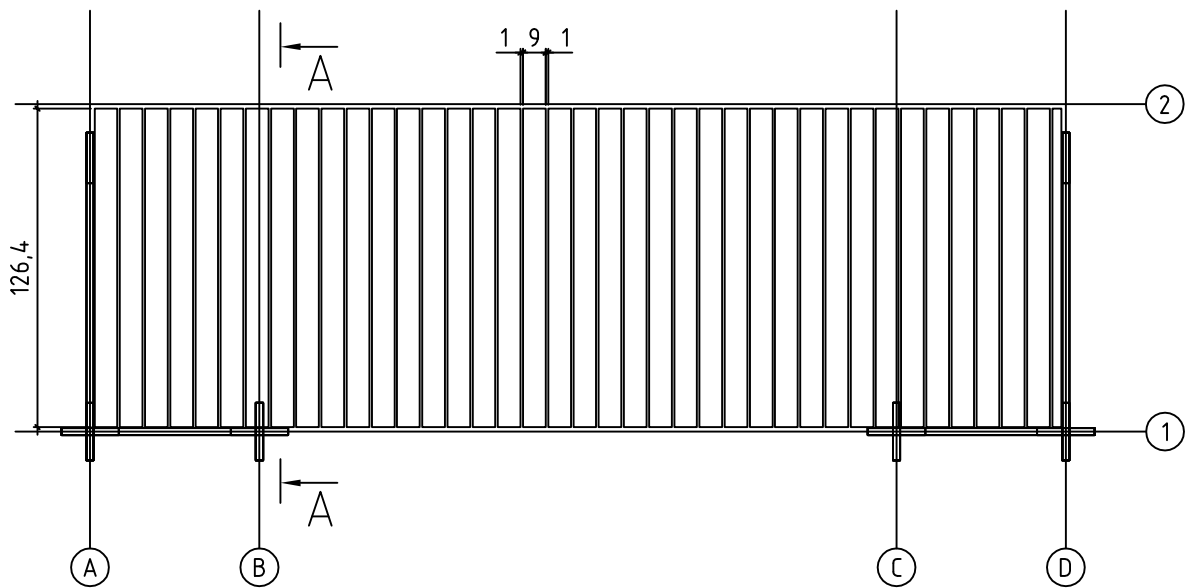

TERRACE BOARDS - TERRASSENBRETTEN - PLANCHER DE TERRASSE

Front view - Vorderansicht - Élévation avant

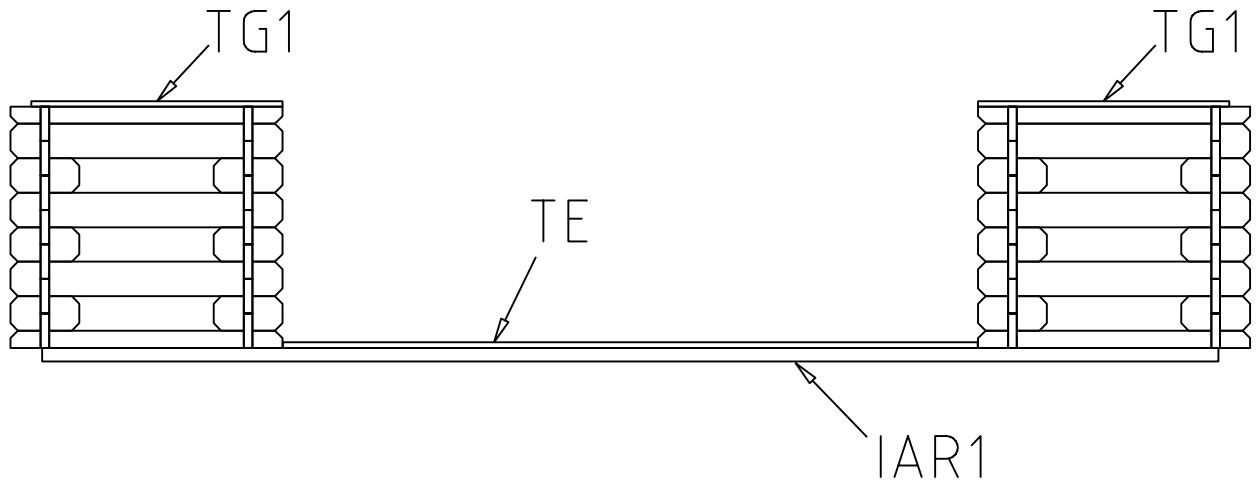

Side view - Seitenansicht - Élévation principale

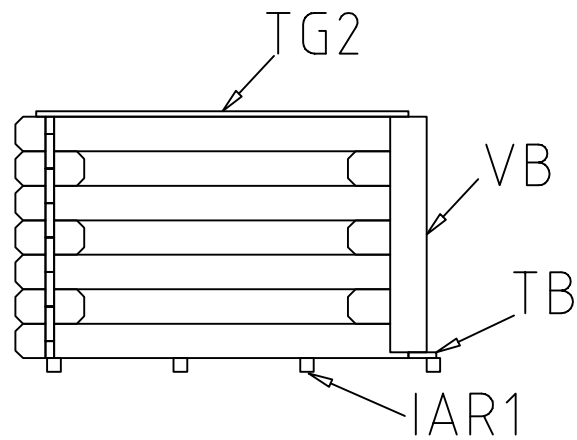



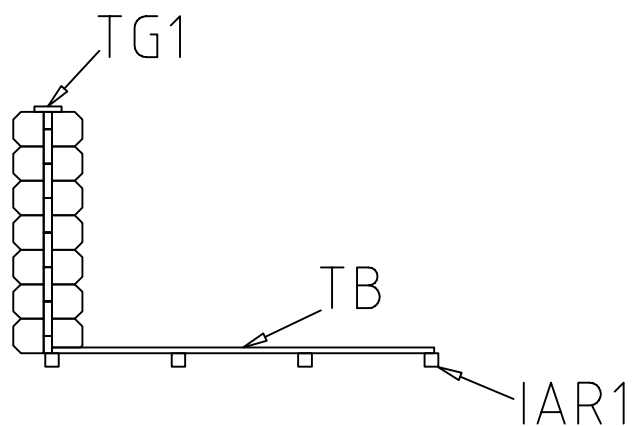



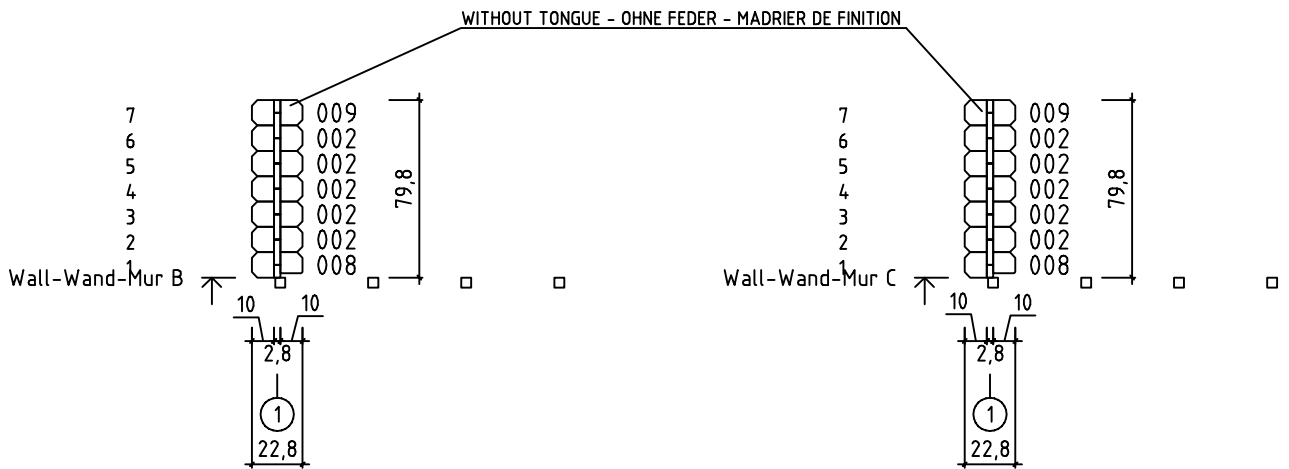
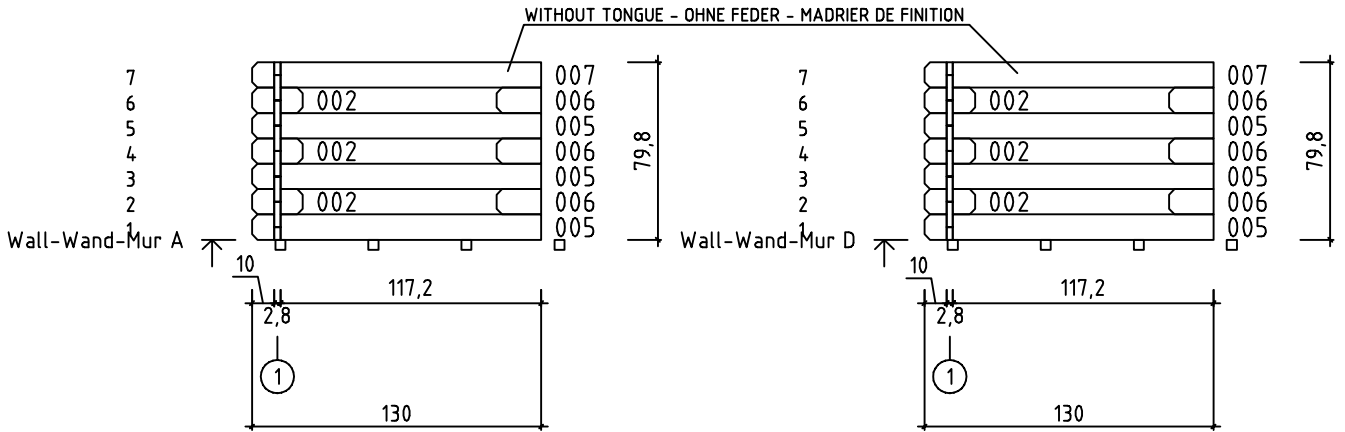
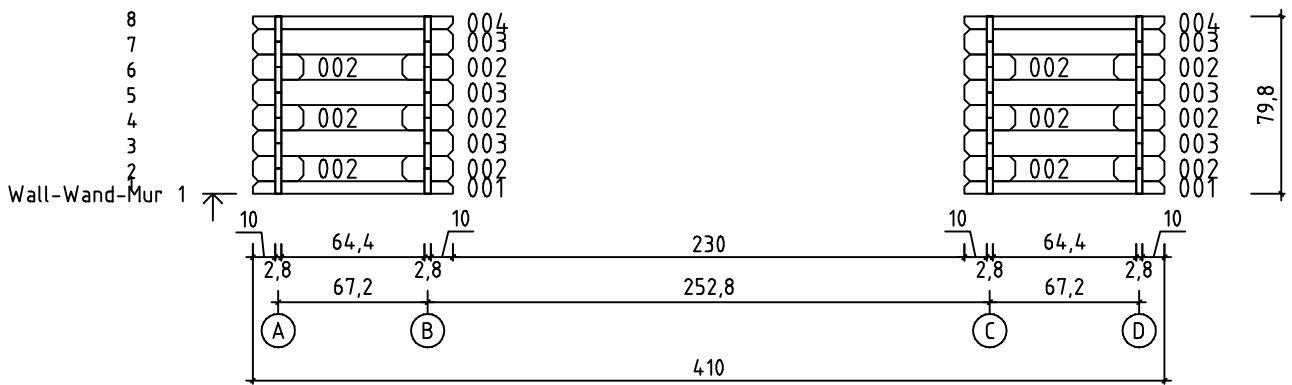

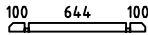

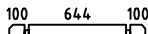
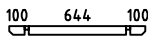
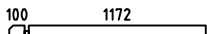

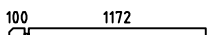
Section - Schnitt - Coupe A-A

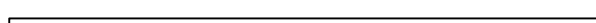

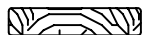
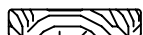
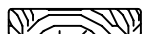
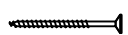
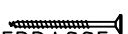
Art.Nr. 285400

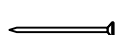

Pos	20.01.2011	Piecelist - Stücklist - Liste des composants Art.Nr. 285400	5/5	Q.	P. (mm)	L. (mm)
001				2	28x57	900
002				28	28x114	228
003				6	28x114	900
004				2	28x57	900
005				6	28x114	1300
006				6	28x114	200
007				2	28x114	1300
008				2	28x114	228
009				2	28x114	228
IAR1	FOUNDATION - FUNDAMENT - FONDATION					
				4	45x45	3890
TB	TERRACE BOARDS - TERRASSENBRETT - PLANCHER DE TERRASSE			39	90x19	1264
TE	TERRACE EDGE BOARD - TERRASSENBRETT, EINGANG - LAME DE SEUIL D'ENTREE DE TERRASSE			1	19x28	2298
TG1	GUARD-RAIL FOR TERRACE - TERRASSENSELÄNDER - MAIN COURANTE DE TERRASSE			2	18x90	831
TG2	GUARD-RAIL FOR TERRACE - TERRASSENSELÄNDER - MAIN COURANTE DE TERRASSE			2	18x90	1231
VB	TERRACE JOIT BOARDS - VERBINDUNGSBRETT - PROFIL DE JONCTION POUR FIXER LA TERRASSE AU MUR			4	18x120	779
	SCREW FOR TERRACE JOIT BOARDS - SCHRAUBEN FÜR VERBINDUNGSBRETT - VIS DE FIXATION PROFIL DE JONCTION TERRASSE			20	3.5x50	
	SCREWS FOR TERRACE EDGE BOARD - SCHRAUBEN FÜR EINGANG, TERRASSENBRETT - VIS DE FIXATION DE LAME DE SEUIL D'ENTREE DE TERRASSE			7	4x40	
	SCREW FOR TERRACE REAR BOARDS - SCHRAUBEN FÜR TERRASSENRAND - VIS DE FIXATION POUR MAIN COURANTE DE TERRASSE			14	4x40	
	SCREW FOR 1. WALL BEAM - SCHRAUBE FÜR 1. BOHLENREIHE - VIS DE FIXATION DES FONDATIONS			4	5x150	
	SCREW FOR 1. WALL BEAM - SCHRAUBE FÜR 1. BOHLENREIHE - VIS DE FIXATION DES FONDATIONS			6	5x90	
	ZN NAIL FOR TERRACE - ZN NÄGEL FÜR TERRASSENBRETT - POINTE POUR PLANCHER DE TERRASSE			312	2.1x50	